

N-Channel Enhancement Mode Field Effect Transistor

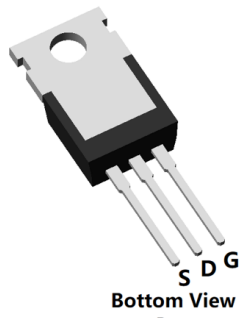

TO-220

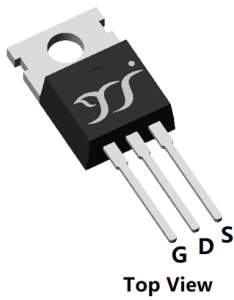
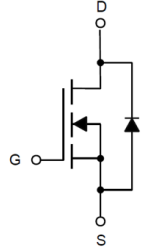

Product Summary

- V_{DS} 200V
- I_D 95A
- $R_{DS(ON)}$ (at $V_{GS}=10V$) $<11.5m\Omega$
- 100% EAS Tested
- 100% ∇V_{DS} Tested

General Description

- Excellent package for heat dissipation
- High density cell design for low $R_{DS(ON)}$
- Epoxy Meets UL 94 V-0 Flammability Rating
- Halogen Free

Applications

- UPS and Inverter applications
- Motor drivers
- DC-DC converter

Limiting Values

Parameter	Conditions		Symbol	Min	Max	Unit
Drain-source Voltage			V_{DS}	-	200	V
Gate-source Voltage			V_{GS}	-20	20	
Continuous Drain Current (Note 1,2)	Steady-State	$T_A=25^\circ C, V_{GS}=10V$	I_D	-	11	A
		$T_A=100^\circ C, V_{GS}=10V$		-	7.8	
Continuous Drain Current (Note 1,3)	Steady-State	$T_C=25^\circ C, V_{GS}=10V, \text{Chip limitation}$		-	95	
		$T_C=100^\circ C, V_{GS}=10V$		-	67	
Pulsed Drain Current	$T_C=25^\circ C, t_p \leq 10\mu s$		I_{DM}	-	380	
Maximum Body-Diode Continuous Current	$T_C=25^\circ C$		I_S		95	
Avalanche energy (non-repetitive)	$T_J=25^\circ C, V_G=10V, R_G=25\Omega, L=0.5mH, I_{AS}=43.4A$		EAS	-	470.89	mJ
Total Power Dissipation (Note 1,2)	Steady-State	$T_A=25^\circ C$	P_D	-	3.7	W
		$T_A=100^\circ C$		-	1.8	
Total Power Dissipation (Note 1,3)	Steady-State	$T_C=25^\circ C$		-	277	
		$T_C=100^\circ C$		-	138	
Junction and Storage Temperature Range			T_J, T_{STG}	-55	175	$^\circ C$

Thermal Resistance

Parameter		Symbol	Typ	Max	Units
Thermal Resistance Junction-to-Ambient (Note 2)	Steady-State	$R_{\theta JA}$	-	40	$^\circ C/W$
Thermal Resistance Junction-to-Case	Steady-State	$R_{\theta JC}$	-	0.54	

Ordering Information (Example)

PREFERRED P/N	PACKING CODE	Marking	MINIMUM PACKAGE(pcs)	INNER BOX QUANTITY(pcs)	OUTER CARTON QUANTITY(pcs)	DELIVERY MODE
YJP012G20H	B1	YJP012G20H	50	/	5000	Tube



YJP012G20H

■ Electrical Characteristics

Parameter	Symbol	Conditions	Min	Typ	Max	Units
Static Parameter						
Drain-Source Breakdown Voltage	BV _{DSS}	V _{GS} =0V, I _D =250μA, T _J =25°C	200	-	-	V
		V _{GS} =0V, I _D =10mA, T _J =25°C	200	-	-	V
Zero Gate Voltage Drain Current	I _{DSS}	V _{DS} =200V, V _{GS} =0V, T _J =25°C	-	-	1	μA
		V _{DS} =200V, V _{GS} =0V, T _J =125°C	-	-	100	
Gate-Source Leakage Current	I _{GSS}	V _{GS} =±20V, V _{DS} =0V, T _J =25°C	-	-	±100	nA
Gate Threshold Voltage	V _{GS(th)}	V _{DS} =V _{GS} , I _D =250μA, T _J =25°C	2.2	3	3.8	V
Static Drain-Source On-Resistance	R _{DS(on)}	V _{GS} =10V, I _D =50A, T _J =25°C	-	9.7	11.5	mΩ
Diode Forward Voltage	V _{SD}	I _S =50A, V _{GS} =0V, T _J =25°C	-	0.85	1.2	V
Gate Resistance	R _G	f=1MHz, T _J =25°C	-	0.8	-	Ω
Dynamic Parameters						
Input Capacitance	C _{iss}	V _{DS} =100V, V _{GS} =0V, f=1MHz, T _J =25°C	-	3920	-	pF
Output Capacitance	C _{oss}		-	445	-	
Reverse Transfer Capacitance	C _{rss}		-	11.3	-	
Switching Parameters						
Total Gate Charge	Q _g	V _{GS} =10V, V _{DS} =100V, I _D =50A, T _J =25°C	-	50.5	-	nC
Gate-Source Charge	Q _{gs}		-	18.4	-	
Gate-Drain Charge	Q _{gd}		-	8.2	-	
Reverse Recovery Charge	Q _{rr}	I _F =50A, di/dt=100A/μs, V _{GS} =0V, V _R =100V, T _J =25°C	-	513	-	nC
Reverse Recovery Time	t _{rr}		-	135	-	ns
Turn-on Delay Time	t _{d(on)}	V _{GS} =10V, V _{DS} =100V, I _D =50A, R _{GEN} =3Ω, T _J =25°C	-	20	-	ns
Turn-on Rise Time	t _r		-	42	-	
Turn-off Delay Time	t _{d(off)}		-	32	-	
Turn-off Fall Time	t _f		-	9	-	

Note:

- The entire application environment impacts the thermal resistance values shown, they are not constants and are only valid for the particular conditions noted.
- The value of R_{θJA} is measured with the device mounted on the 40mm*40mm*1.1mm single layer FR-4 PCB board with 1 in² pad of 2oz. Copper, in the still air environment with T_A=25°C. The maximum allowed junction temperature of 175°C. The value in any given application depends on the user's specific board design.
- Thermal resistance from junction to soldering point (on the exposed drain pad).



YJP012G20H

Typical Electrical and Thermal Characteristics Diagrams

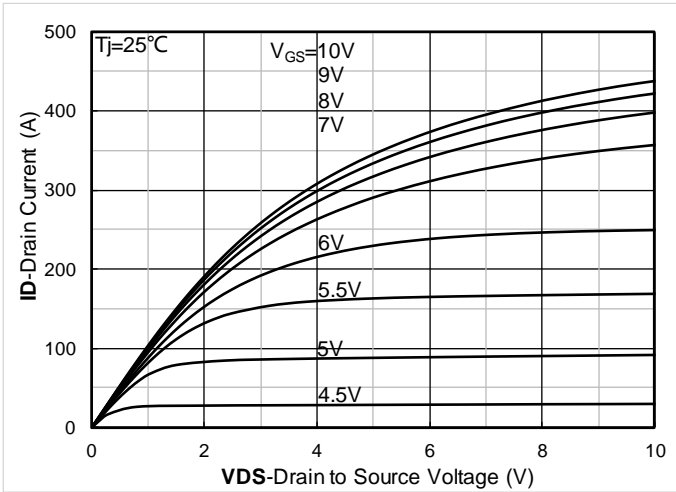

Figure 1. Output Characteristics; typical values

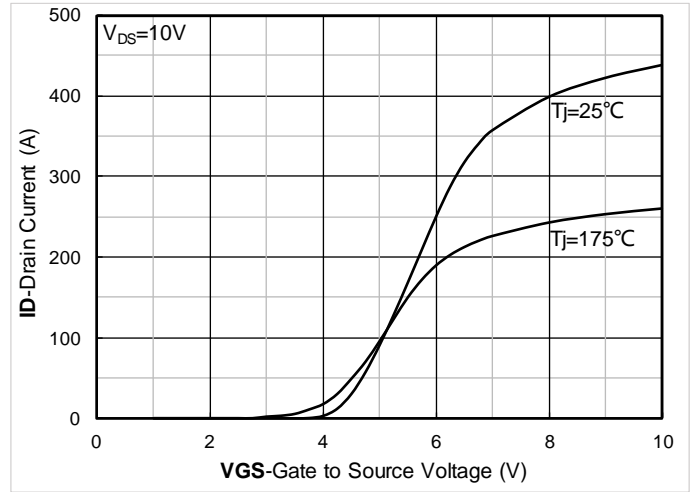

Figure 2. Transfer Characteristics; typical values

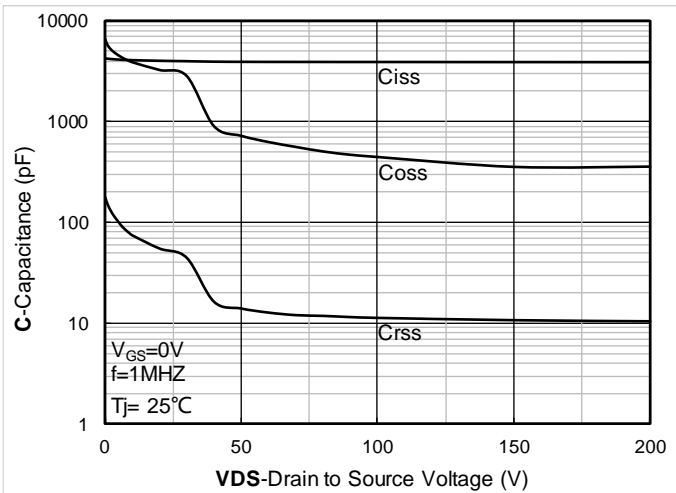

Figure 3. Capacitance Characteristics; typical values

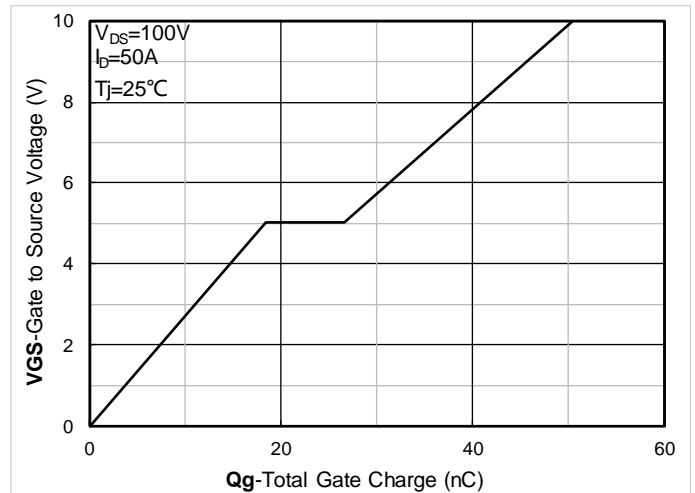

Figure 4. Gate Charge; typical values

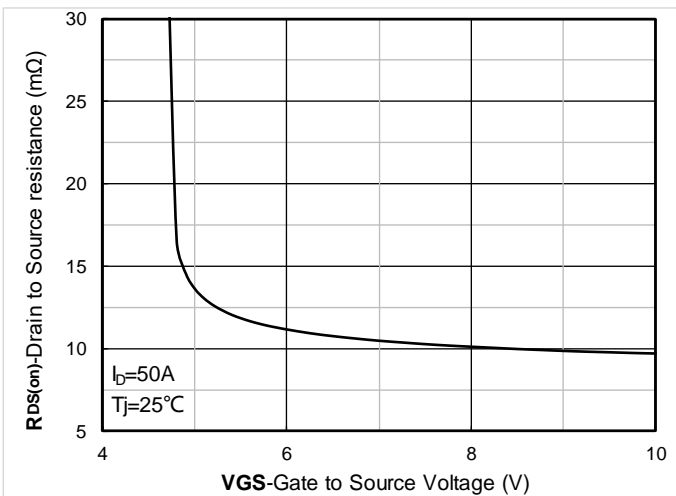

Figure 5. On-Resistance vs. Gate to Source Voltage; typical values

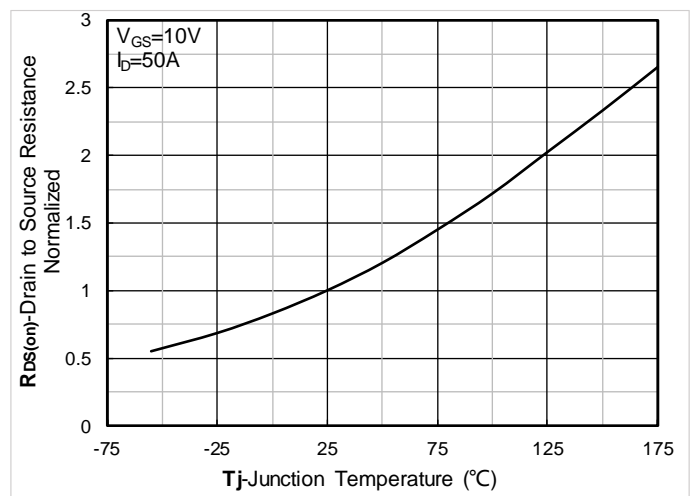

Figure 6. Normalized On-Resistance



YJP012G20H

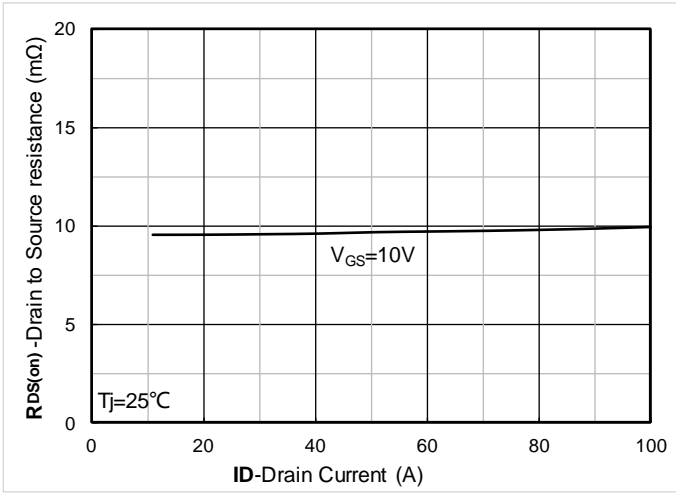

Figure 7. RDS(on) vs. Drain Current; typical values

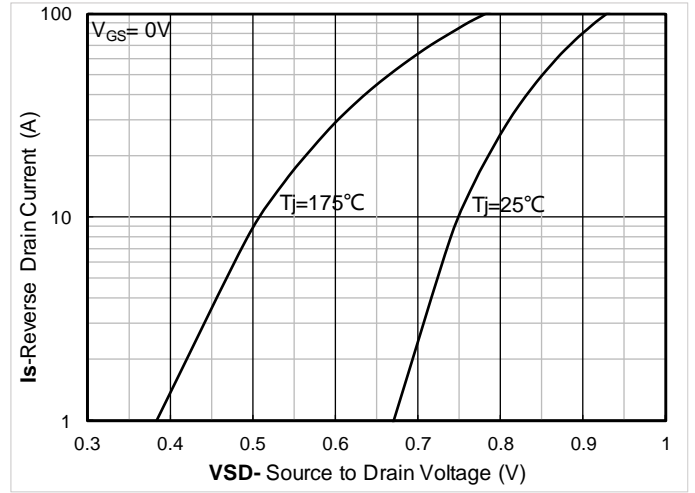

Figure 8. Forward characteristics of reverse diode; typical values

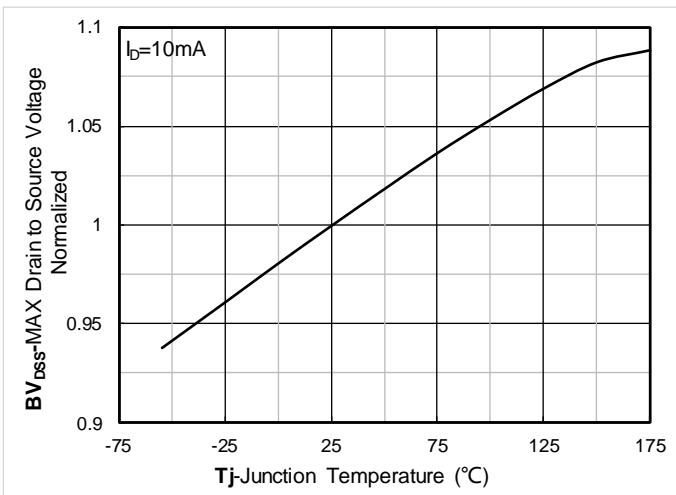

Figure 9. Normalized breakdown voltage

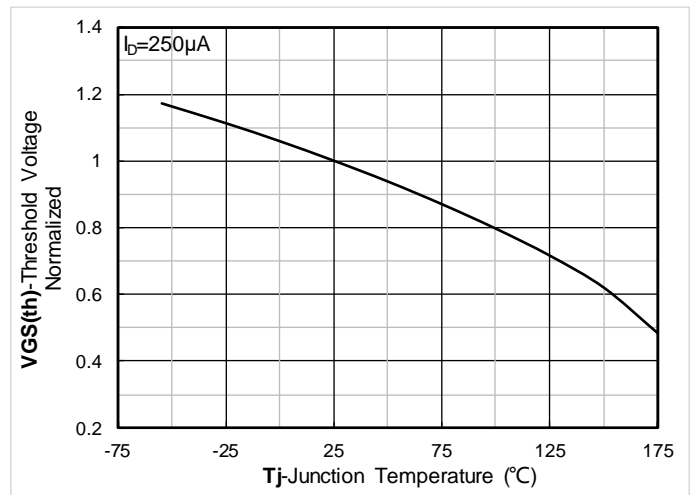

Figure 10. Normalized Threshold voltage

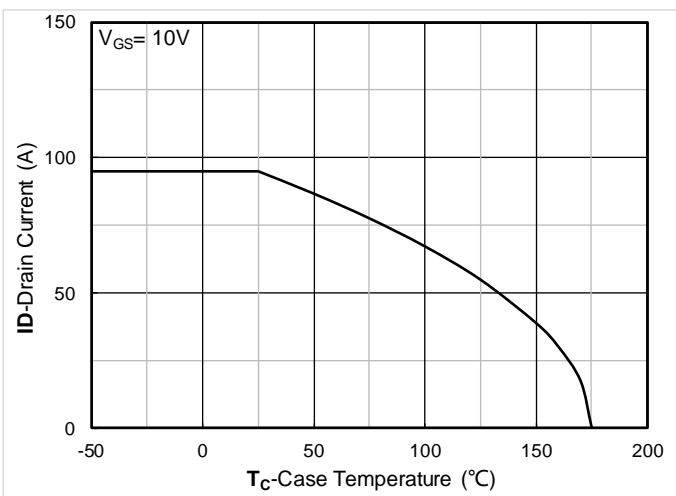

Figure 11. Current dissipation

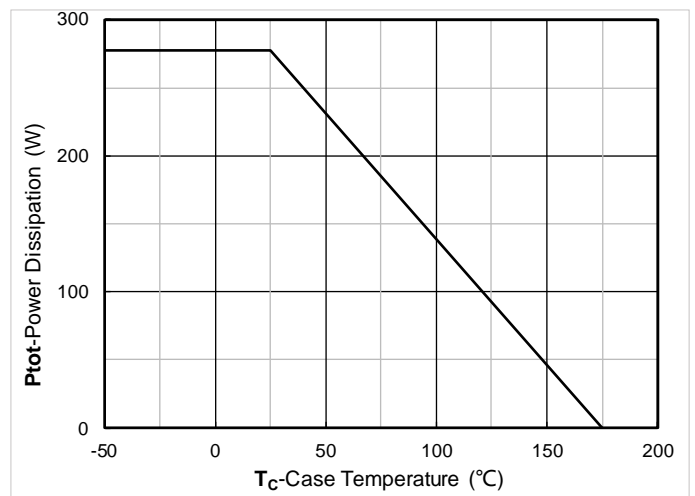

Figure 12. Power dissipation



YJP012G20H

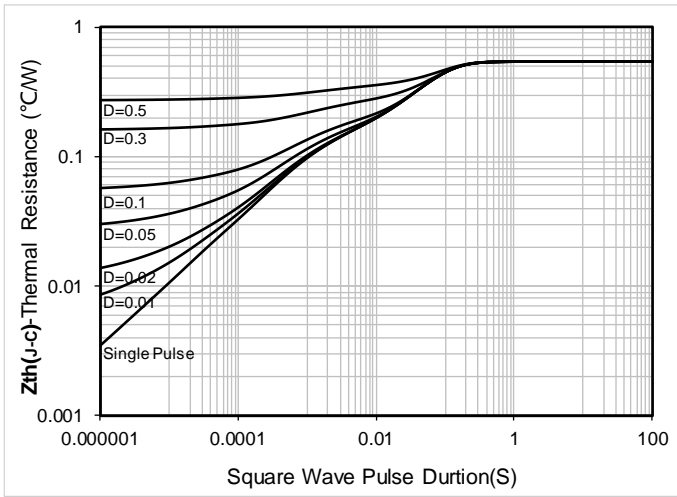

Figure 13. Maximum Transient Thermal Impedance

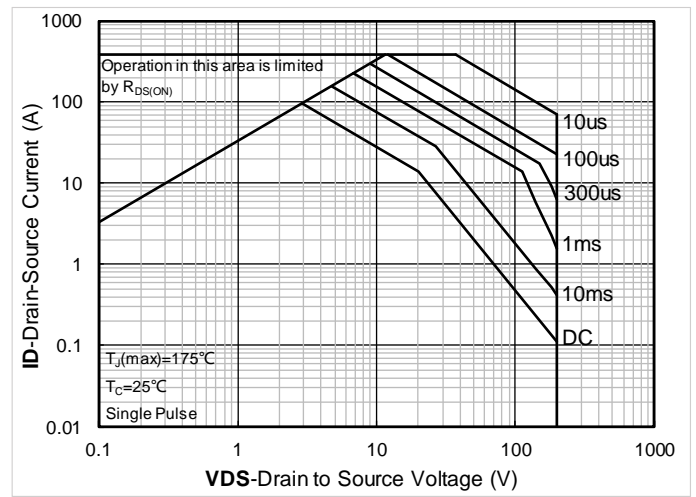

Figure 14. Safe Operation Area

■ Test Circuits & Waveforms

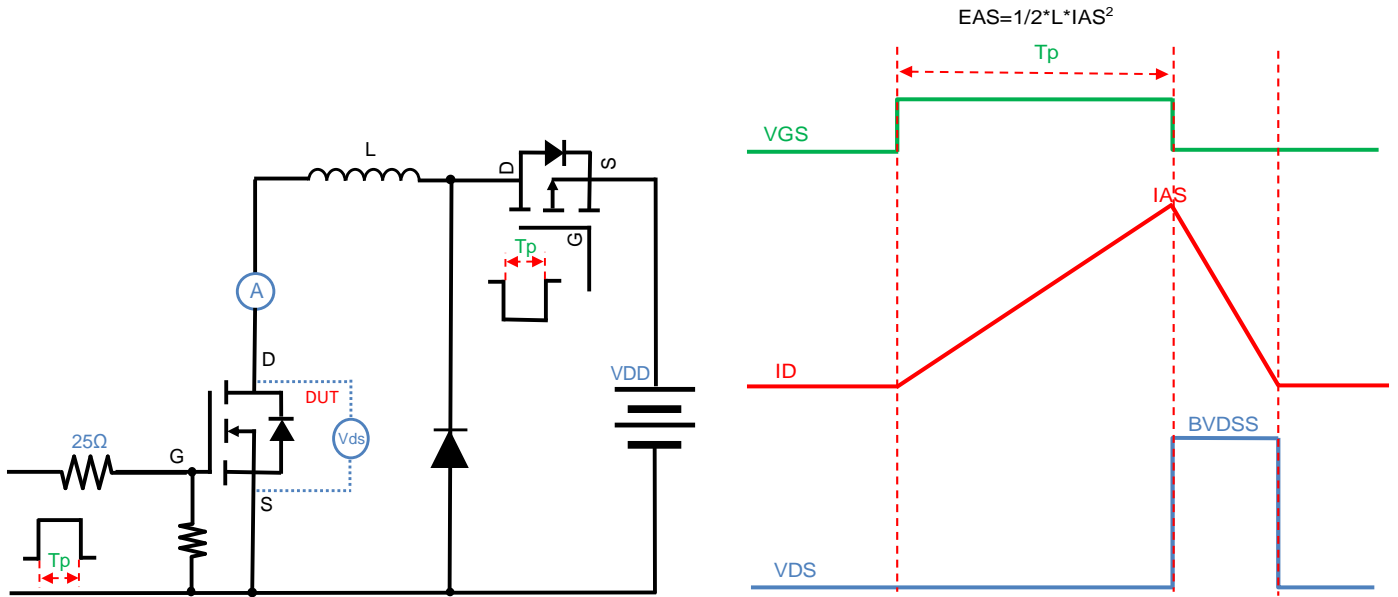

Figure A. Unclamped Inductive Switching (UIS) Test Circuit & Waveform

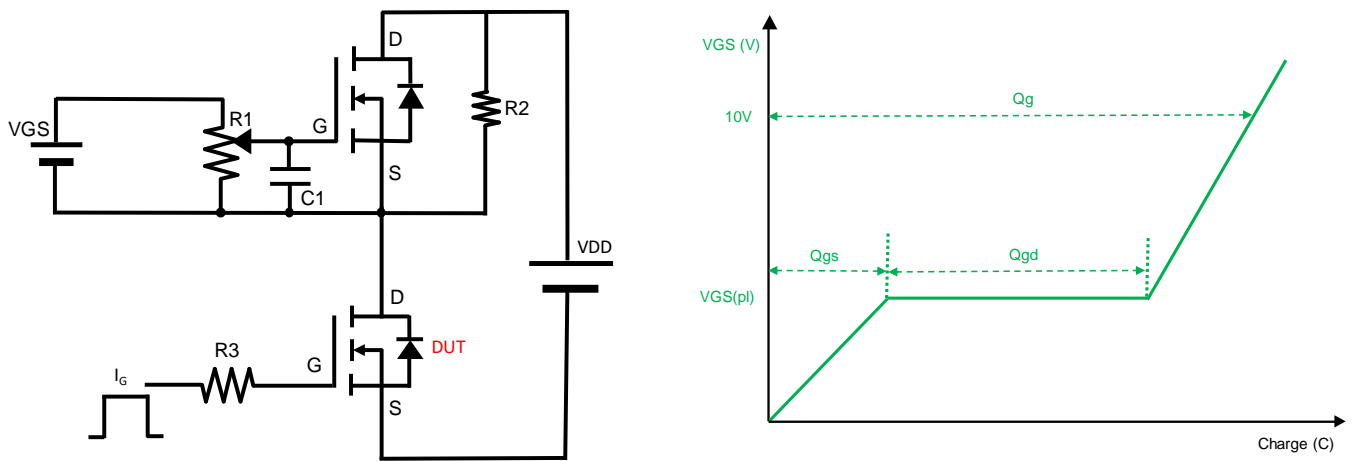

Figure B. Gate Charge Test Circuit & Waveform

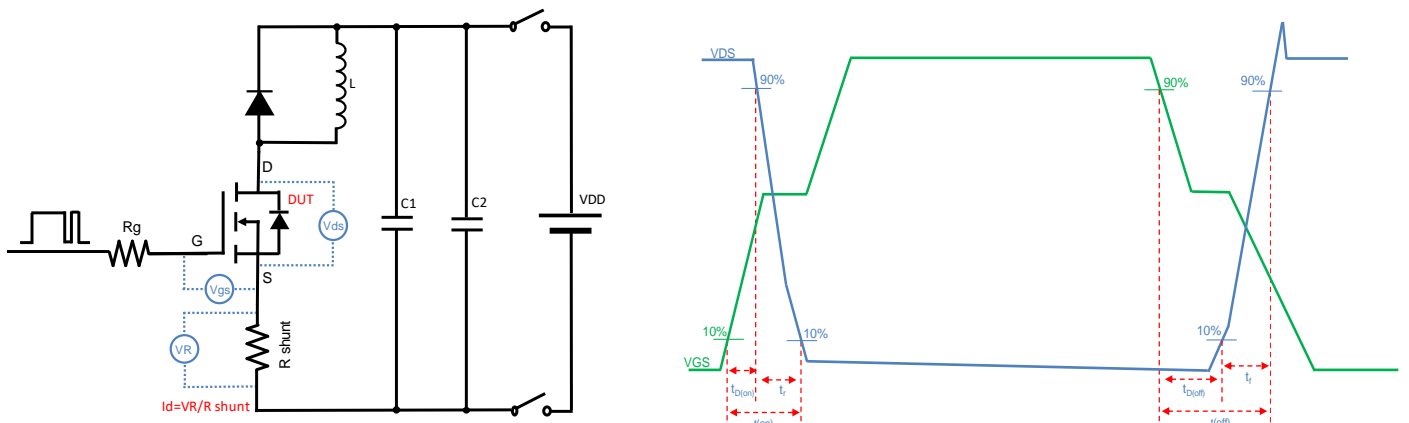

Figure C. Resistive Switching Test Circuit & Waveform

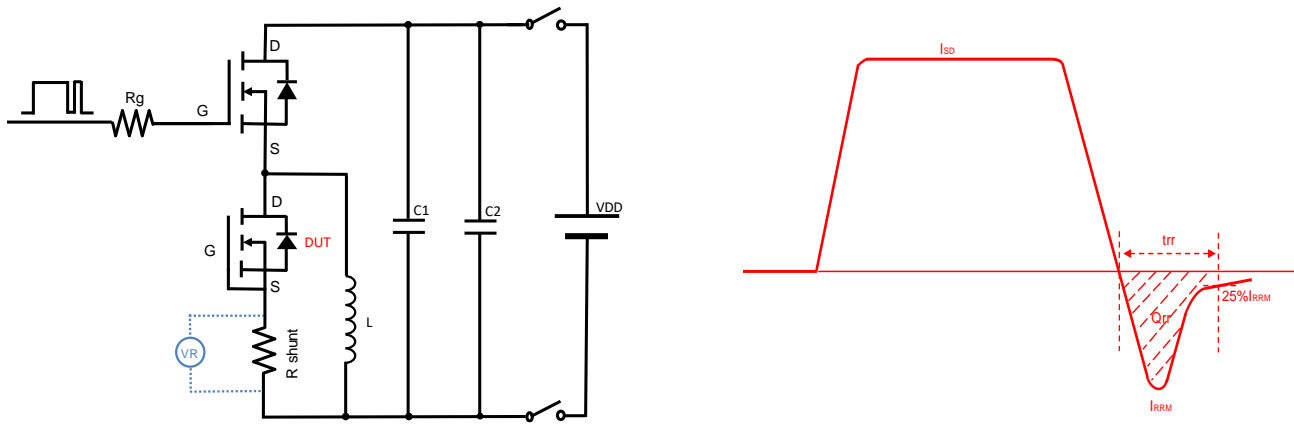
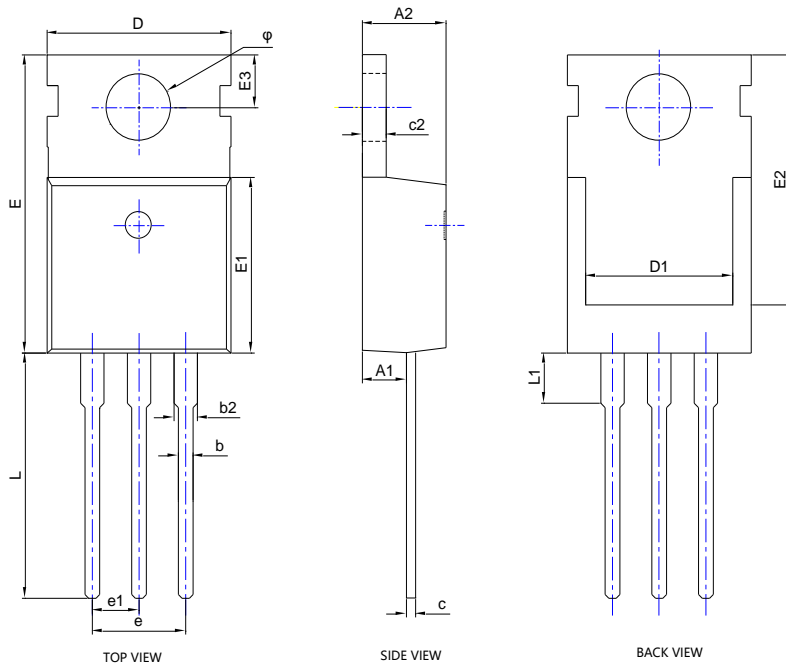

Figure D. Diode Recovery Test Circuit & Waveform



YJP012G20H

■ TO-220AB-E Package information



SYMBOL	DIMENSIONS			
	INCHES		Millimeter	
	MIN.	MAX.	MIN.	MAX.
A1	0.093	0.114	2.350	2.900
A2	0.176	0.184	4.470	4.670
b	0.028	0.036	0.710	0.910
b2	0.048	0.054	1.220	1.360
c	0.019	0.024	0.470	0.600
c2	0.047	0.055	1.200	1.400
D	0.382	0.408	9.700	10.370
D1	0.276	0.350	7.000	8.890
E	0.579	0.622	14.700	15.800
E1	0.350	0.373	8.900	9.470
E2	0.463	0.535	11.750	13.600
E3	0.108BSC		2.740BSC	
e	0.200BSC		5.080BSC	
e1	0.100BSC			
L	0.508	0.583	12.900	14.800
L1	0.100	0.151	2.540	3.840
φ	0.142	0.154	3.600	3.900

NOTE:
1.PACKAGE BODY SIZES EXCLUDE MOLD FLASH AND GATE BURRS.
2.TOLERANCE 0.1mm UNLESS OTHERWISE SPECIFIED.



YJP012G20H

Disclaimer

The information presented in this document is for reference only. Yangzhou Yangjie Electronic Technology Co., Ltd. reserves the right to make changes without notice for the specification of the products displayed herein to improve reliability, function or design or otherwise.

The product listed herein is designed to be used with ordinary electronic equipment or devices, and not designed to be used with equipment or devices which require high level of reliability and the malfunction of which would directly endanger human life (such as medical instruments, transportation equipment, aerospace machinery, nuclear-reactor controllers, fuel controllers and other safety devices), Yangjie or anyone on its behalf, assumes no responsibility or liability for any damages resulting from such improper use of sale.

This publication supersedes & replaces all information previously supplied. For additional information, please visit our website <http://www.21yangjie.com> , or consult your nearest Yangjie's sales office for further assistance.