

## Silicon Carbide Power MOSFET (N-Channel Enhancement)

$V_{DS}$	1200V
$I_D$ (25°C)	42.5A
$R_{DS(on)}$	60mΩ

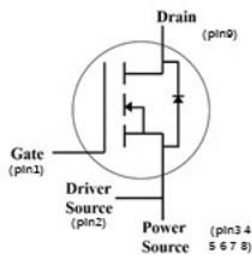
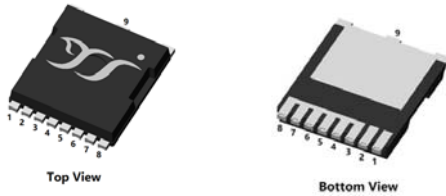

### Features

- High speed switching
- Essentially no switching losses
- Reduction of heat sink requirements
- Maximum working temperature at 175 °C
- High blocking voltage
- Fast Intrinsic diode with low recovery current
- High-frequency operation
- Halogen free, RoHS compliant

### Typical Applications

Typical applications are in power factor correction(PFC), solar inverter, uninterruptible power supply, motor drives, photovoltaic inverter, electric car and charger.

### Mechanical Data

- **Package:** TOLL
- **Terminals:** Tin plated leads
- **Polarity:** As marked

### ■Maximum Ratings ( $T_c=25^\circ\text{C}$ Unless otherwise specified)

PARAMETER	SYMBOL	UNIT	VALUE	TEST CONDITIONS	NOTE
Device marking code				D212060TLGH	
Drain source voltage @ $T_j=25^\circ\text{C}$	$V_{DS,max}$	V	1200	$V_{GS}=0\text{ V}$ , $I_D=100\mu\text{A}$	
Gate source voltage @ $T_j=25^\circ\text{C}$	$V_{GS,max}$	V	-10/+25	Absolute maximum values (AC $f > 1\text{Hz}$ , duty cycle $< 1\%$ )	Note1
Gate source voltage @ $T_j=25^\circ\text{C}$	$V_{GS,op}$	V	-5/+20	Recommended operational values	
Continuous drain current @ $T_c=25^\circ\text{C}$	$I_D$	A	42.5	$V_{GS}=20\text{V}$ , $T_c=25^\circ\text{C}$	Fig.14
Continuous drain current @ $T_c=110^\circ\text{C}$			28.5	$V_{GS}=20\text{V}$ , $T_c=110^\circ\text{C}$	
Pulse Drain Current	$I_{D,pulse}$	A	121	Limited by $t_{pw}$	Fig.19
Avalanche energy, Single Pulse	$E_{AS}$	J	1.25	$V_{DD}=75\text{V}$ , $L=25\mu\text{H}$	
Power Dissipation	$P_{TOT}$	W	234.4	$T_c=25^\circ\text{C}$ , $T_j = 175^\circ\text{C}$	Fig.13
Operating junction and Storage temperature range	$T_j, T_{stg}$	$^\circ\text{C}$	-55 to +175		
Soldering temperature	$T_L$	$^\circ\text{C}$	260	1.6mm (0.063") from case for 10s	



### ■Static Electrical Characteristics (Tc=25°C unless otherwise specified)

PARAMETER	SYMBOL	UNIT	Min.	Typ.	Max.	Test Conditions	Note
Gate threshold voltage	$V_{GS(th)}$	V	2.0	2.8	4.0	$V_{DS}=V_{GS}$ , $I_D=20mA$	Fig.15
Drain source breakdown voltage	$V_{(BR)DSS}$	V	1200			$V_{GS}=0$ , $I_D=100\mu A$	
Zero gate voltage drain current	$I_{DSS}$	$\mu A$		<1	50	$V_{DS}=1200V$ , $V_{GS}=0V$	
				10	500	$V_{DS}=1200V$ , $V_{GS}=0V$ , $T_J=175^\circ C$	
Gate source leakage current	$I_{GSS}$	nA			250	$V_{GS}=20V$ , $V_{DS}=0V$	
Current drain source on-state resistance	$R_{DS(on)}$	$m\Omega$		60	80	$V_{GS}=20V$ , $I_D=20A$	Fig.4,5,6
				110		$V_{GS}=20V$ , $I_D=20A$ , $T_J=175^\circ C$	
Transconductance	$g_f$	S		13.3		$V_{DS}=20V$ , $I_D=40A$	Fig.7

### ■Dynamic Electrical Characteristics (Tc=25°C unless otherwise specified)

PARAMETER	SYMBOL	UNIT	Min.	Typ.	Max.	Test Conditions	Note
Input capacitance	$C_{iss}$	$pF$		1721.8		$V_{DS}=800V$ , $V_{GS}=0V$ , $T_J=25^\circ C$ , $f=1MHz$ , $V_{AC}=25mV$	Fig.11
Output capacitance	$C_{oss}$			97.35			
Reverse capacitance	$C_{rss}$			13.9			
Coss stored energy	$E_{oss}$	$\mu J$		36.3			Fig.12
Gate source charge	$Q_{gs}$	$nC$		31.1		$V_{DS}=800V$ , $V_{GS}=-5/20V$ , $I_D=20A$	Fig.16
Gate drain charge	$Q_{gd}$			74.7			
Gate charge	$Q_g$			117			
Short-Circuit Withstand Time	$t_{sc}$	$\mu s$		3.6		$R_g=30\Omega$ , $I_D=376A$ , $V_{GS}=-5/20V$ , $V_{DD}=800V$	
Internal Gate Resistance	$R_{G(int)}$	$\Omega$		2.5		$f=1MHz$ , $V_{AC}=25mV$	

### ■Switching Characteristics (Tc=25°C unless otherwise specified)

PARAMETER	SYMBOL	UNIT	Min.	Typ.	Max.	Test Conditions	Note
Turn on delay time	$t_{d(on)}$	$ns$		19.9		$V_{DD}=800V$ , $V_{GS}=-5/+20V$ , $I_D=20A$ , $L=200\mu H$ , $R_{G(ext)}=2.7\Omega$	Fig.17,18,22
Rise time	$t_r$			12.3			
Turn off delay time	$t_{d(off)}$			7.0			
Fall time	$t_f$			17.1			
Turn on switching energy	$E_{on}$	$\mu J$		344.2			
Turn off switching energy	$E_{off}$			51.3			



## Body diode characteristics (Tc=25°C unless otherwise specified)

PARAMETER	SYMBOL	UNIT	Min.	Typ.	Max.	Test Conditions	Note
Diode forward voltage	$V_{SD}$	V		4.0		$V_{GS}=0V, I_{SD}=10A$	Fig.8
Continuous diode forward current	$I_S$	A		43.3		$V_{GS}=0V, T_c=25^\circ C$	
Reverse recovery time	$t_{rr}$	nS		20.5		$V_{DS}=800V, V_{GS}=0V, I_{SD}=10A, di/dt=300A/\mu S$	
Reverse recovery charge	$Q_{rr}$	nC		69.3			
Peak reverse recovery current	$I_{rrm}$	A		4.1			

Note 1: When using SiC Body Diode the maximum recommended  $V_{GS} = -5V$

## Thermal Characteristics (Ta=25°C Unless otherwise specified)

PARAMETER	SYMBOL	UNIT	Value
Thermal resistance	$R_{\theta J-C}$	$^\circ C/W$	0.64

## Typical Characteristics

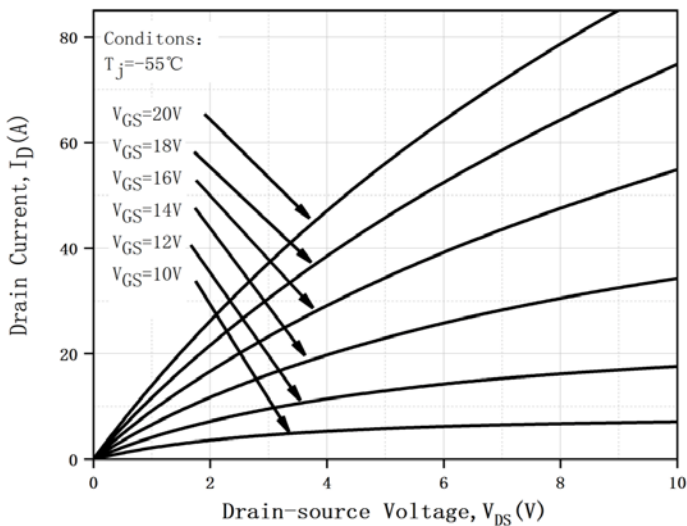

Figure 1. Output Characteristics Tj = -55°C

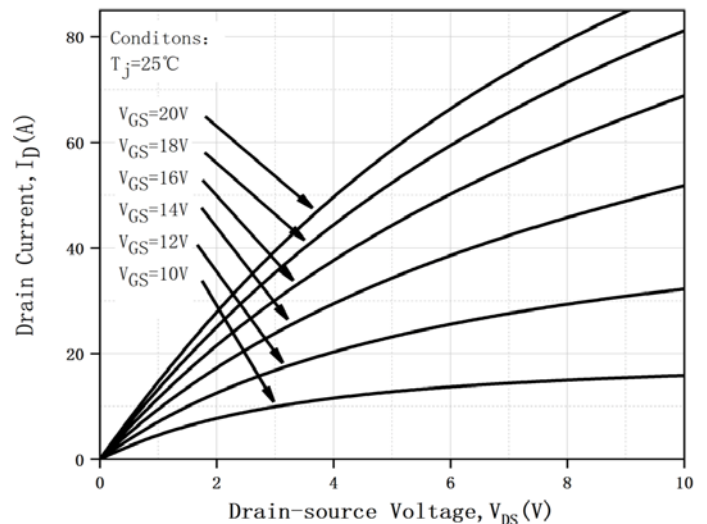

Figure 2. Output Characteristics Tj = 25°C

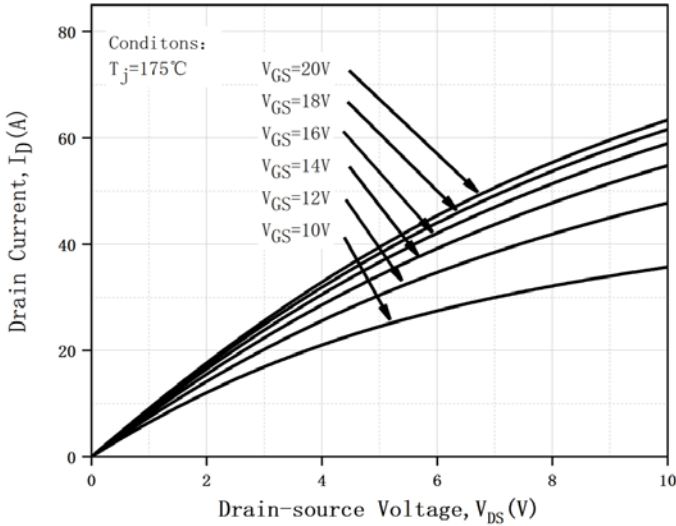

Figure 3. Output Characteristics Tj = 175°C

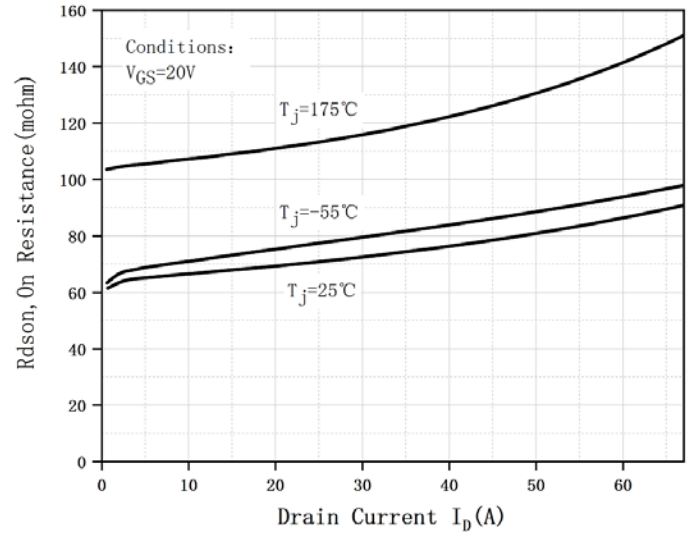

Figure 4. On-resistance vs. drain current

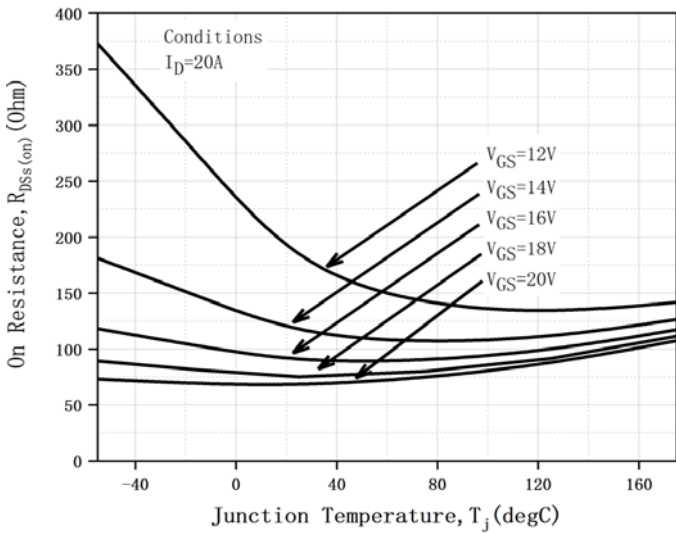

Figure 5. On-resistance vs. Tj for various gate voltage

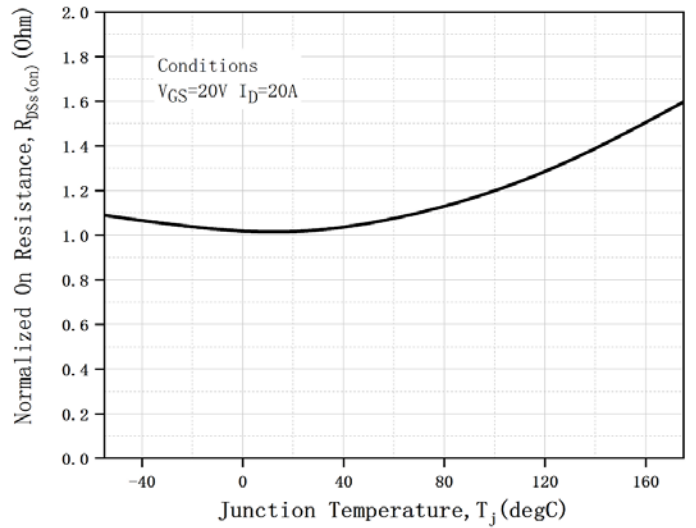

Figure 6. Normalized On-Resistance vs. Temperature

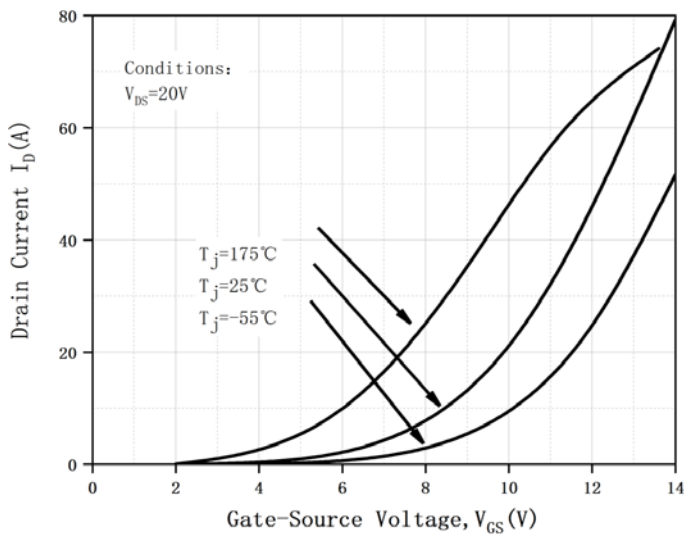

Figure 7. Transfer Characteristics for various Tj

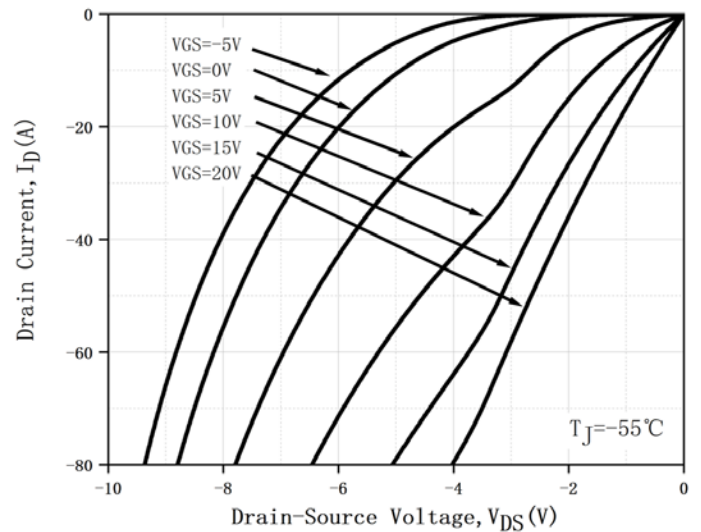

Figure 8. Reverse Output Characteristics at Tj = -55°C

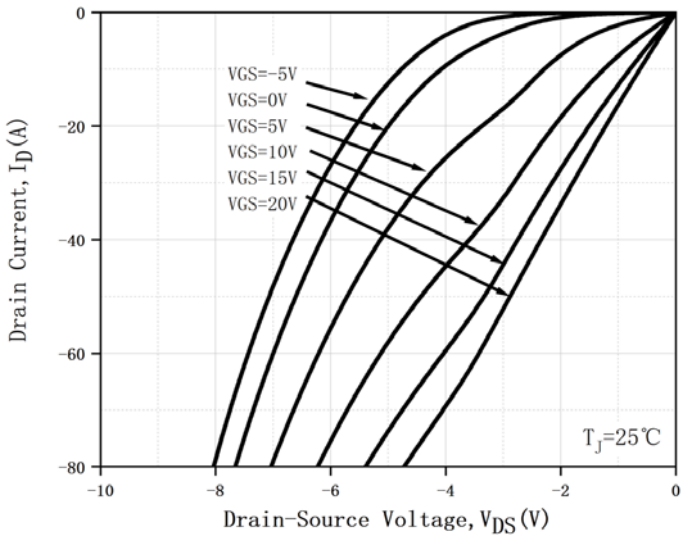

Figure 9. Reverse Output Characteristics at Tj = 25°C

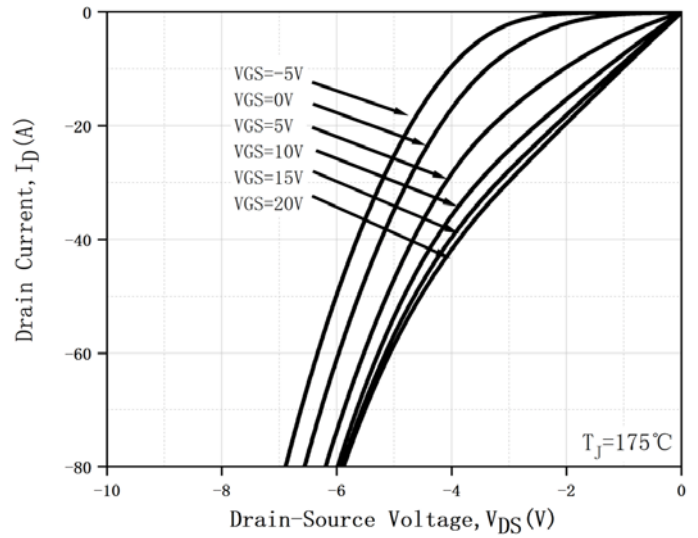

Figure 10. Reverse Output Characteristics at Tj = 175°C

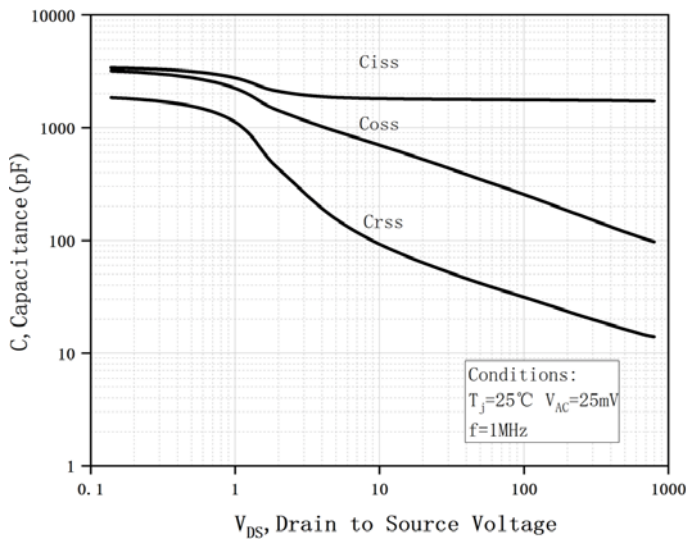

Figure 11. Capacitances vs. Drain to Source Voltage

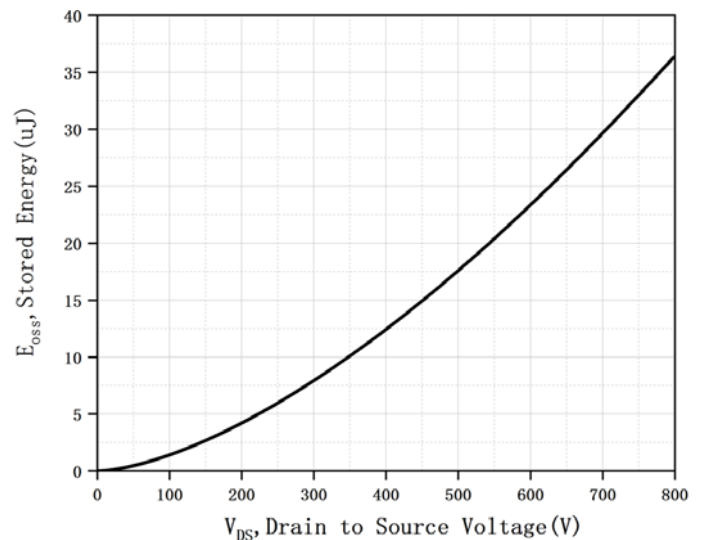

Figure 12. Output Capacitor Stored Energy

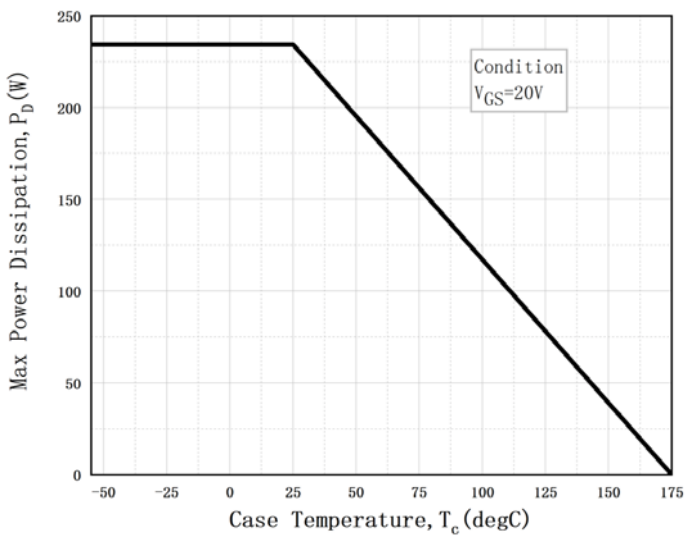

Figure 13. Maximum Power Dissipation Derating vs. Case Temperature

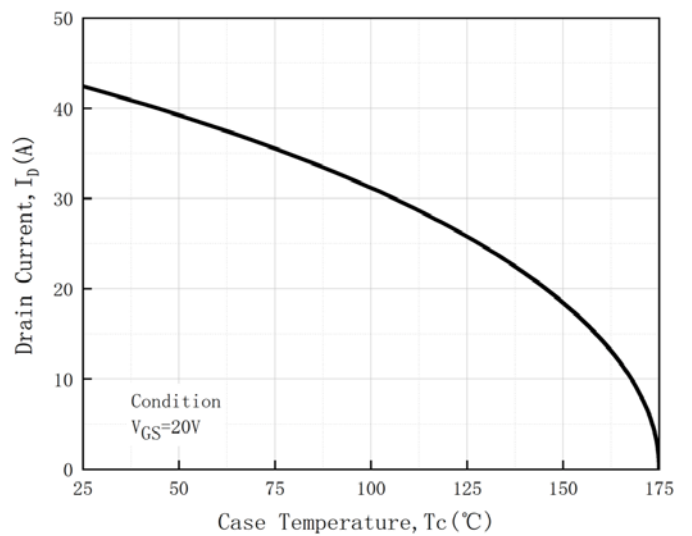

Figure 14. Drain Current vs. Case Temperature

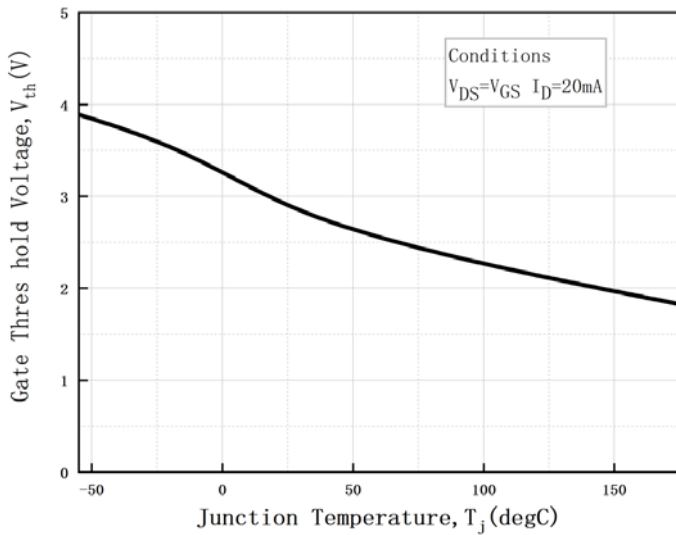

Figure 15. Threshold voltage vs.temperature

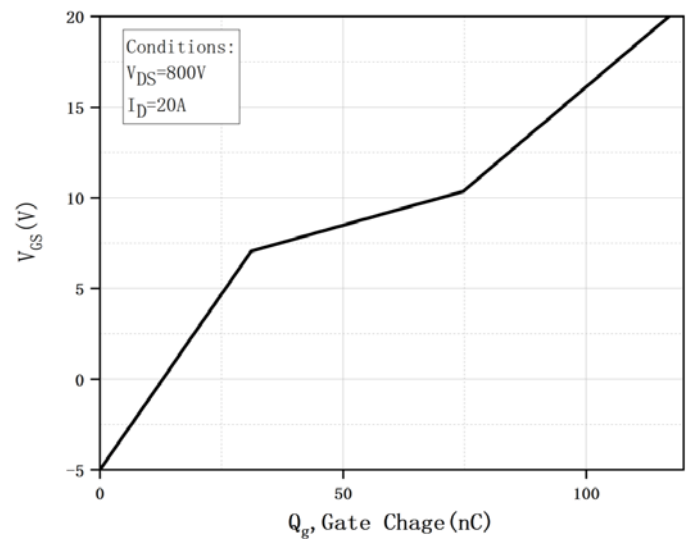

Figure 16. Gate Charge Characteristics

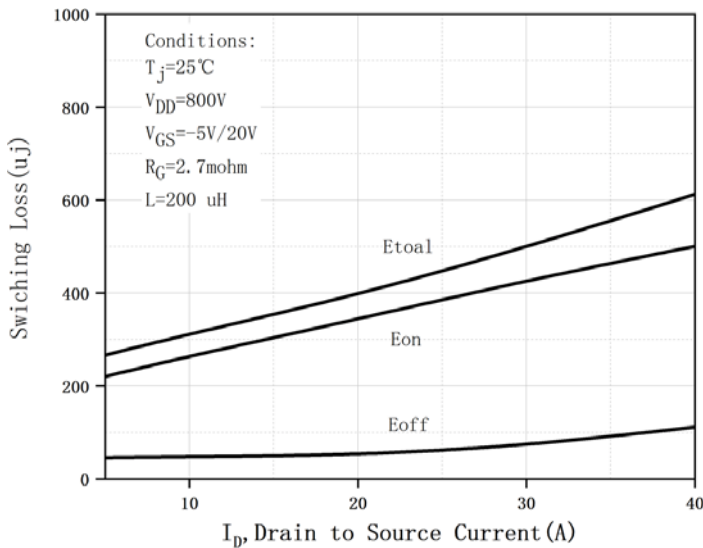

Figure 17. Clamped Inductive Switching Energy vs. Drain Current

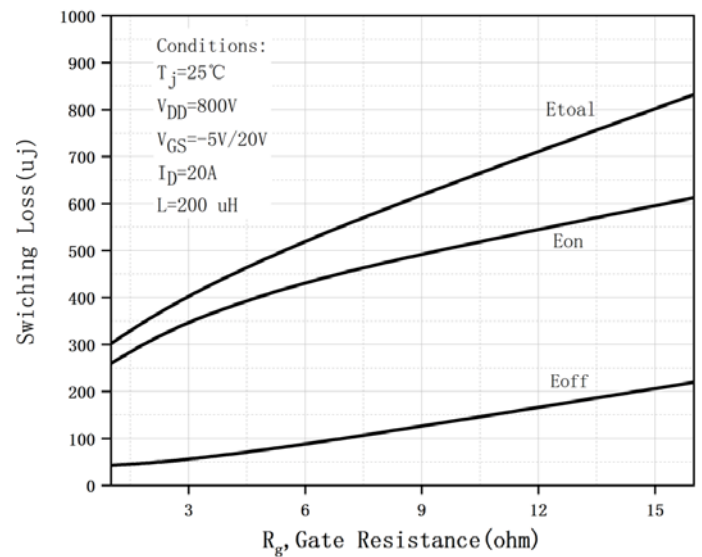

Figure 18. Clamped Inductive Switching Energy vs. External Gate Resistor ( $R_{G(ext.)}$ )

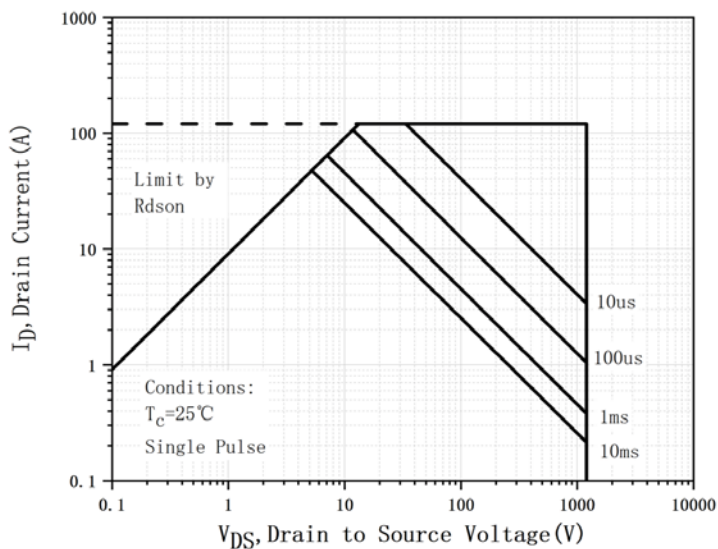

Figure 19. Safe Operating Area

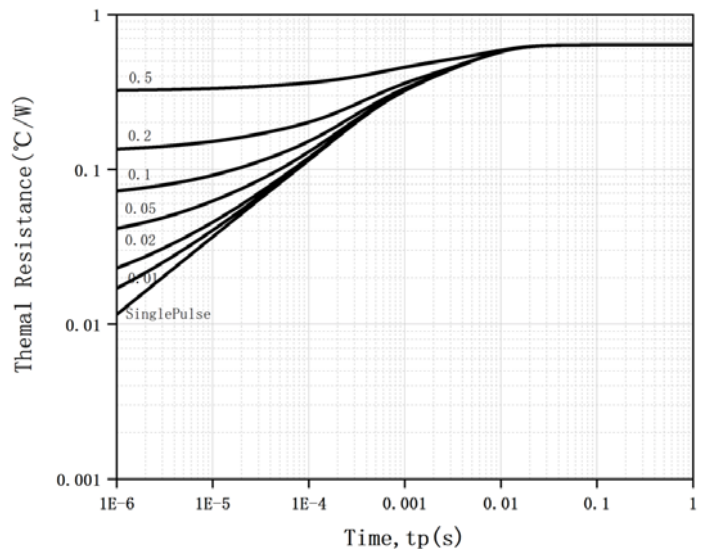

Figure 20. Transient Junction to Case Thermal Impedance

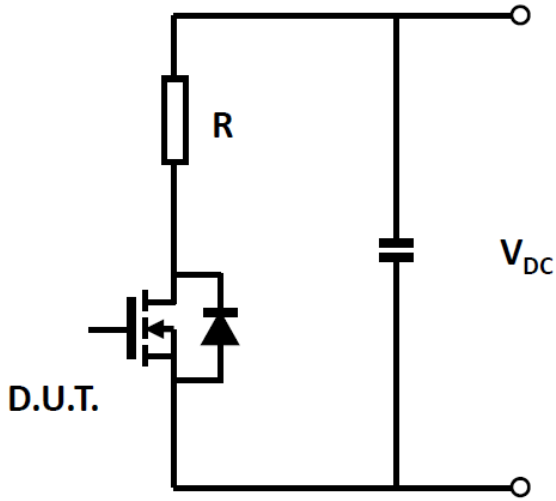

Figure 21. Schematic of Resistive Switching

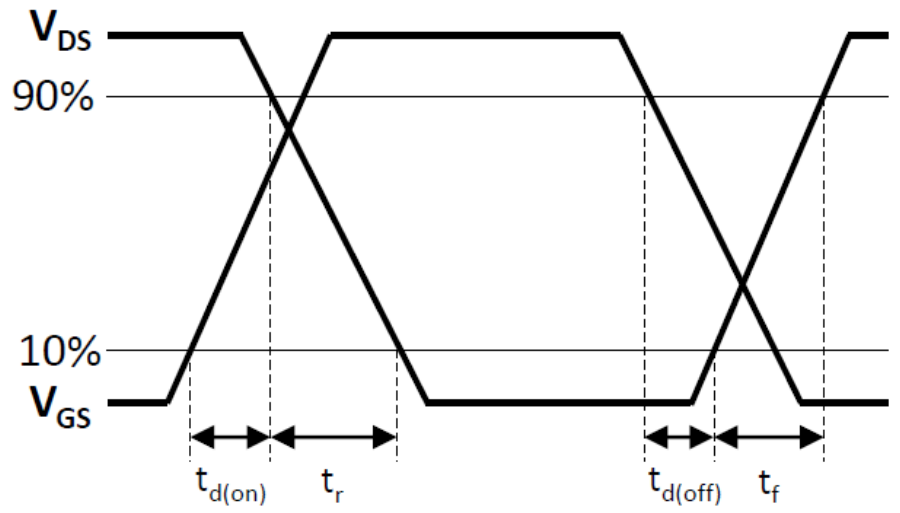
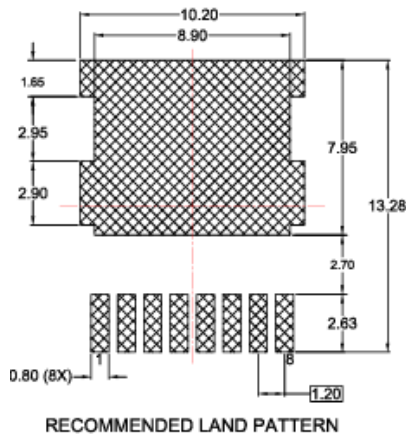
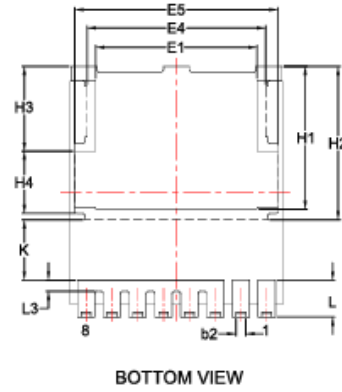
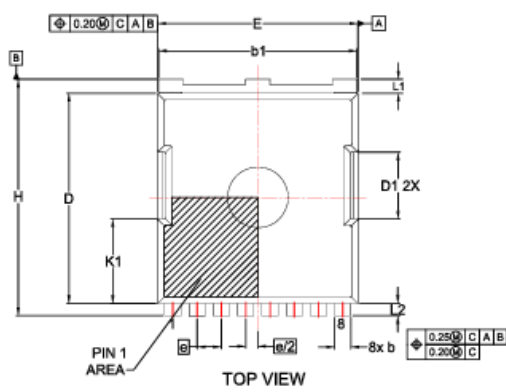

Figure 22. Switching Times Definition

## Outline Dimensions



DIM	MILLIMETERS		
	MIN	NOM	MAX
A	2.20	2.3	2.40
b	0.70	0.80	0.90
b1	0.70	0.80	0.90
b2	0.36	0.46	0.56
c	0.40	0.50	0.60
D	10.28	10.38	10.48
D1	3.30		
E	9.80	9.90	10.00
E1	8.0	8.10	8.20
E4	8.40		
E5	9.40		
e	1.20 BSC		
e2	0.60 BSC		
H	11.58	11.68	11.78
H1	6.56	6.66	6.76
H2	7.05	7.15	7.25
H3	3.50		
H4	3.25		
K	2.70	2.80	2.90
K1	4.18		
L	1.63	1.73	1.83
L1	0.60	0.70	0.80
L2	0.50	0.60	0.70
L3	0.30	0.40	0.50
E	8 REF		





---

**Disclaimer**

The information presented in this document is for reference only. Yangzhou Yangjie Electronic Technology Co., Ltd. reserves the right to make changes without notice for the specification of the products displayed herein to improve reliability, function or design or otherwise.

The product listed herein is designed to be used with ordinary electronic equipment or devices, and not designed to be used with equipment or devices which require high level of reliability and the malfunction of which would directly endanger human life (such as medical instruments, transportation equipment, aerospace machinery, nuclear-reactor controllers, fuel controllers and other safety devices), Yangjie or anyone on its behalf, assumes no responsibility or liability for any damages resulting from such improper use of sale.

This publication supersedes & replaces all information previously supplied. For additional information, please visit our website [http:// www.21yangjie.com](http://www.21yangjie.com) , or consult your nearest Yangjie's sales office for further assistance.